

DAIKIN

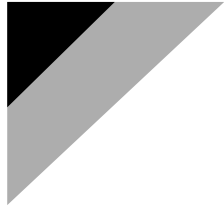

OPERATION MANUAL

SPLIT SYSTEM

HEAT PUMP

MODELS

Air Handling Unit

FTQ18PBVJU

FTQ24PBVJU

FTQ30PBVJU

FTQ36PBVJU

FTQ42PBVJU

English

Français

Español

Read these instructions carefully before installation.
Keep this manual in a handy place for future reference.
This manual should be left with the equipment owner.

Lire soigneusement ces instructions avant l'installation.
Conserver ce manuel à portée de main pour référence ultérieure.
Ce manuel doit être donné au propriétaire de l'équipement.

Lea cuidadosamente estas instrucciones antes de instalar.
Guarde este manual en un lugar a mano para leer en caso de tener alguna duda.
Este manual debe permanecer con el propietario del equipo.

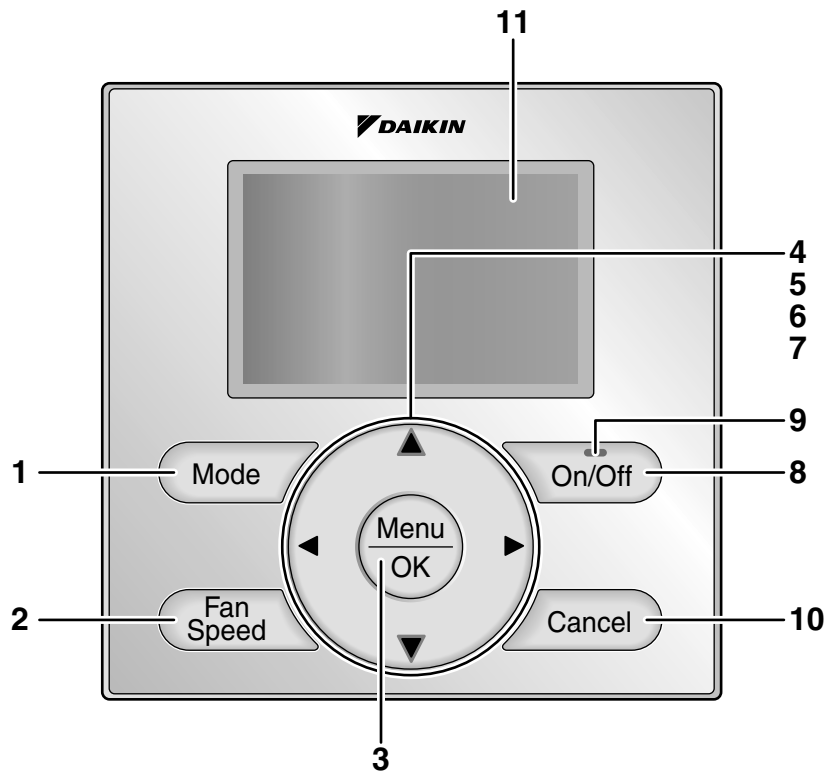

1

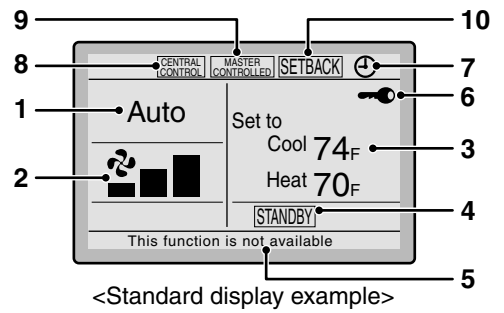
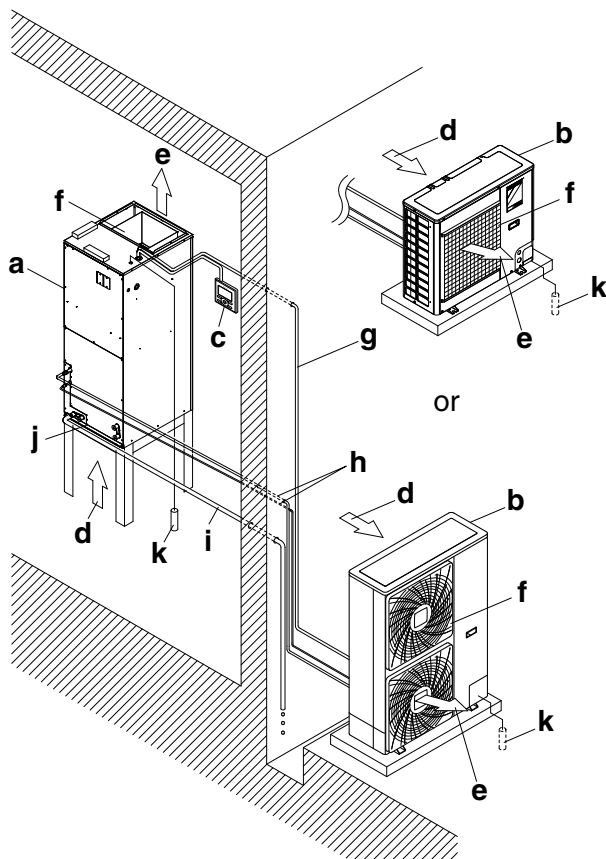

3

2

CONTENTS

ILLUSTRATIONS	[1]
1. WHAT TO DO BEFORE OPERATION	1
2. SAFETY CONSIDERATIONS	1
3. OPERATION RANGE	5
4. INSTALLATION SITE	5
5. LABELS AND CORRESPONDING FUNCTIONS OF THE REMOTE CONTROLLER	5
6. OPERATION PROCEDURE	6
7. OPTIMUM OPERATION	9
8. MAINTENANCE (FOR SERVICE PERSONNEL)	10
9. MALFUNCTIONS NOT RELATED TO HEAT PUMP	12
10. TROUBLE SHOOTING	13

1. WHAT TO DO BEFORE OPERATION

This operation manual is for the following system with standard control. Before initiating operation, contact your dealer for the operation that corresponds to your system.

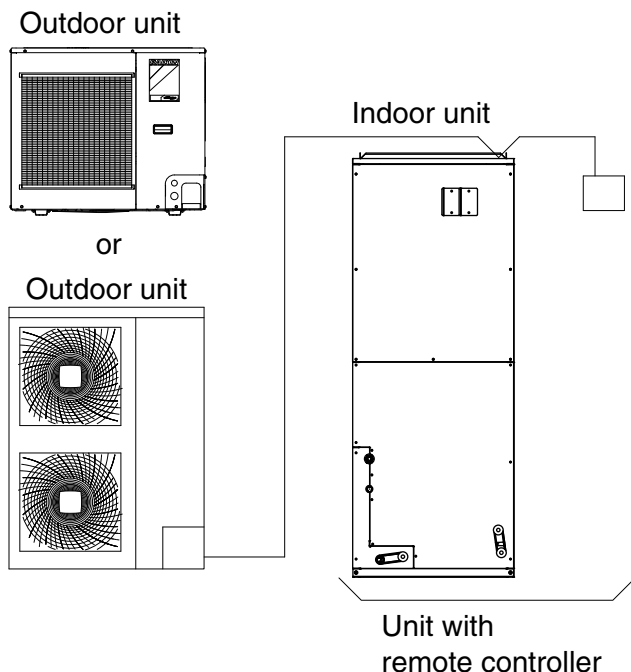

NOTE

- If the unit you purchased is controlled by the wired remote controller (BRC1E71), refer to the operation manual of the wired remote controller (BRC1E71).

If your installation has a customized control system, ask your dealer for the operation that corresponds to your system.

TWO REMOTE CONTROLLERS CONTROL SYSTEM

Confirm the following if your unit is the following control system type.

- **Two remote controllers control system**
Two remote controllers control one indoor unit.
The unit is individually operated.

NOTE

- Contact your dealer in case of two remote controllers control system.

Names and functions of parts

Refer to figure 2 on page [1]

a	Indoor unit
b	Outdoor unit
c	Remote controller
d	Air inlet
e	Discharged air
f	Air outlet
g	Transmission wiring
h	Refrigerant piping
i	Drain pipe
j	Air inlet The built-in air filter removes dust and dirt.
k	Ground wire Wire to ground from the outdoor unit to prevent electrical shocks.

2. SAFETY CONSIDERATIONS

Read these “Safety Considerations for Operations” carefully before installing air conditioning or heat pump equipment. After completing the installation, make sure that the unit operates properly during the startup operation. Instruct the customer on how to operate and maintain the unit.

Inform customers that they should store this Operation Manual with the Installation Manual for future reference.

This air conditioner is classified under “appliances not accessible to the general public”.

- After reading, keep this manual in a convenient place so that you can refer to it whenever necessary. If the equipment is transferred to a new user, be sure also to hand over the manual.

Meanings of **DANGER**, **WARNING**, **CAUTION**, and **NOTE** Symbols:

- ⚠ **DANGER** Indicates an imminently hazardous situation which, if not avoided, will result in death or serious injury.
- ⚠ **WARNING** Indicates a potentially hazardous situation which, if not avoided, could result in death or serious injury.
- ⚠ **CAUTION** Indicates a potentially hazardous situation which, if not avoided, may result in minor or moderate injury. It may also be used to alert against unsafe practices.
- ⚠ **NOTE**..... Indicates situations that may result in equipment or property-damage accidents only.

— ⚠ **DANGER** —

- Do not install the unit in an area where flammable materials are present due to risk of explosion resulting in serious injury or death.
- Any abnormalities in the operation of the air conditioner or heat pump such as smoke or fire, could result in severe injury or death. Turn off the power and contact your dealer immediately.
- Refrigerant gas may produce toxic gas if it come in contact with fire, such as from a fan, heater, stove, or cooking device. Exposure to this gas could cause severe injury or death.
- Consult your local dealer regarding modification, repair and maintenance of the air conditioner. Improper workmanship may result in water leakage, electric shocks or fire hazards.
- For refrigerant leakage, consult your dealer. Refrigerant gas is heavier than air and replaces oxygen. A massive leak could lead to oxygen depletion, especially in basements, and an asphyxiation hazard could occur leading to serious injury or death.

- If equipment utilizing a burner is used in the same room as the air conditioner or heat pump, there is the danger of oxygen deficiency which could lead to an asphyxiation hazard resulting in serious injury or death. Be sure to ventilate the room sufficiently to avoid this hazard.
- Safely dispose of the packing materials. Packing materials, such as nails and other metal or wooden parts, may cause stabs or other injuries.
- Tear apart and throw away plastic packaging bags so that children will not play with them. Children playing with plastic bags face the danger of death by suffocation.
- Do not install the air conditioner at any place where there is a danger of flammable gas leakage. In the event of a gas leakage, build-up of gas near the air conditioner may result in fire hazards.

— ⚠ **WARNING** —

- Contact your dealer for repair and maintenance. Improper repair and maintenance may result in water leakage, electric shock, and fire. Only use accessories made by Daikin that are specifically designed for use with the equipment and have them installed by a professional.
- Contact your dealer to move and reinstall the air conditioner or heat pump. Incomplete installation may result in water leakage, electric shock, and fire.
- Never let the indoor unit or the remote controller get wet. Water can cause an electric shock or a fire.
- Never use flammable spray such as hair spray, lacquer, or paint near the unit. Flammable spray may cause a fire.
- When a fuse blows out, never replace it with one of incorrect ampere ratings or different wires. Always replace any blown fuse with a fuse of the same specification.
- Never remove the fan guard of the unit. A fan rotating at high speed without the fan guard is very dangerous.
- Never inspect or service the unit by yourself. Contact a qualified service person to perform this work.

- Shut off all electrical power before doing any maintenance to avoid the risk of serious electric shock; never sprinkle or spill water or liquids on the unit.
- Do not touch the switch with wet fingers. Touching a switch with wet fingers can cause electric shock.
- Do not allow children to play on or around the unit to prevent injury.
- The heat exchanger fins are sharp enough to cut. To avoid injury wear gloves or cover the fins while working around them.
- Do not put a finger or other objects into the air inlet or air outlet. The fan is rotating at high speed and will cause injury.
- Check the unit foundation for damage on a continuous basis, especially if it has been in use for a long time. If left in a damaged condition the unit may cause injury.
- Placing a flower vase or other containers with water or other liquids on the unit could cause a shock or fire if a spill occurs.
- Never touch the internal parts of the controller. Do not remove the front panel because some parts inside are dangerous to touch. To check and adjust internal parts, contact your dealer.
- Be aware that prolonged, direct exposure to cool or warm air from the air conditioner, or to air that is too cool or too warm can be harmful to your physical condition and health.
- Ask your dealer to install in a machine room that has no water drops by raining. This unit is for indoor use. Incomplete installation performed by yourself may result in a water leakage, electric shock, and fire.

⚠ CAUTION

- Do not use the air conditioner or heat pump for any other purposes other than comfort cooling or heating. Do not use the unit for cooling precision instruments, food, plants, animals or works of art.
- Do not place items under the indoor unit as they may be damaged by condensates that may form if the humidity is above 80% or if the drain outlet gets blocked.

- Before cleaning, stop the operation of the unit by turning the power off or by pulling the supply cord out from its receptacle. Otherwise, an electric shock and injury may result.
 - Do not wash the air conditioner or heat pump with excessive water. An electric shock or fire may result.
 - Avoid placing the controller in a spot splashed with water. Water entering the controller may cause an electric shock or damage the internal electronic parts.
 - Do not operate the air conditioner or heat pump when using a room-fumigation type of insecticide. Failure to observe this could cause the chemicals to be deposited in the unit and can endanger the health of those who are hypersensitive to chemicals.
 - Do not shut off the power immediately after stopping operation. Always wait for at least five minutes before shutting off the power. Otherwise, water leakage may occur.
 - The appliance is not intended for use by young children or infirm persons without supervision.
 - The remote controller should be kept away from children so they cannot play with it.
 - Consult with the installation contractor for cleaning.
 - Incorrect cleaning of the inside of the air conditioner or heat pump could make the plastics parts break and cause water leakage or electric shock.
 - Do not touch the air inlet or aluminum fin of the air conditioner or heat pump as they can cut and cause injury.
 - Do not place objects in direct proximity of the outside unit. Do not let leaves and other debris accumulate around the unit. Leaves are a hotbed for small animals which can enter the unit. Once inside the unit, animals can cause the unit to malfunction, and cause smoke or fire when they make contact with electrical parts.
 - Be sure that children, plants or animals are not exposed directly to airflow from the unit, as adverse effects may ensue.
-

NOTE

- Never press the button of the remote controller with a hard, pointed object. The remote controller may be damaged.
 - Never pull or twist the electric wire of the remote controller. It may cause the unit to malfunction.
 - Do not place appliances that produce open flames in places that are exposed to the air flow of the unit or under the indoor unit. It may cause incomplete combustion or deformation of the unit due to the heat.
 - Do not wipe the controller operation panel with benzine, thinner, chemical dustcloth, etc. The panel may get discolored or the coating peeled off. If it is heavily dirty, soak a cloth in water-diluted neutral detergent, squeeze it well and wipe the panel clean. And wipe it with another dry cloth.
 - Do not expose the controller to direct sunlight. The LCD display can become discolored and may fail to display the data.
 - Dismantling of the unit, disposal of the refrigerant, oil, and additional parts, should be done in accordance with the relevant local, state, and national regulations.
 - Operate the air conditioner or heat pump in a sufficiently ventilated area and not surrounded by obstacles. Do not use the air conditioner or heat pump in the following places.
 - a. Places with a mist of mineral oil, such as cutting oil.
 - b. Locations such as coastal areas where there is a lot of salt in the air.
 - c. Locations such as hot springs where there is a lot of sulfur in the air.
 - d. Locations such as factories where the power voltage varies a lot.
 - e. In cars, boats, and other vehicles.
 - f. Locations such as kitchens where oil may splatter or where there is steam in the air.
 - g. Locations where equipment produces electromagnetic waves.
 - h. Places with an acid or alkaline mist.
 - i. Places where fallen leaves can accumulate or where weeds can grow.
 - Take snow protection measures. Contact your dealer for the details of snow protection measures, such as the use of a snow protection hood.
- Do not attempt to do electrical work or grounding work unless you are licensed to do so. Consult with your dealer for electrical work and grounding work.
 - Pay Attention to Operating Sound. Be sure to use the following places:
 - a. Places that can sufficiently withstand the weight of the air conditioner or heat pump yet can suppress the operating sound and vibration of the air conditioner or heat pump.
 - b. Places where warm air from the air outlet of the outside unit or the operating sound of the outside unit does not annoy neighbors.
 - Make sure that there are no obstacles close to the outside unit. Obstacles close to the outside unit may drop the performance of the outside unit or increase the operating sound of the outside unit.
 - Consult your dealer if the air conditioner or heat pump in operation generates unusual noise.
 - Make sure that the drainpipe is installed properly to drain water. If no water is discharged from the drainpipe while the air conditioner or heat pump is in the cooling mode, the drainpipe may be clogged with dust or dirt and water leakage from the indoor unit may occur. Stop operating the air conditioner or heat pump and contact your dealer.
 - Carry out drain piping properly to ensure complete drainage. If drain piping is not carried out properly, drain will not flow out. Then, dirt and debris may be accumulated in the drain pipe and may cause water leakage. If it occurs, stop the air conditioner and call your dealer for assistance.

3. OPERATION RANGE

If the temperature or the humidity is beyond the following conditions, safety devices may work and the air conditioner or heat pump may not operate, or sometimes, water may drop from the indoor unit.

OPERATION	TEMPERATURE (°F)	
	OUTDOOR	INDOOR
COOLING	23 to 115 (DB)	57 to 77 (WB)
HEATING	0 to 60 (WB)	59 to 80.5 (DB)

DB: Dry bulb temperature

WB: Wet bulb temperature

The setting temperature range of the remote controller is 60°F to 90°F.

4. INSTALLATION SITE

Regarding places for installation

- **Is the air conditioner or heat pump installed at a well-ventilated place where there are no obstacles around?**
- **Do not use the air conditioner or heat pump in the following places:**
 - a. An atmosphere laden with mineral oil
 - b. Places with an abundance of salt such as coastal areas
 - c. Where sulfured gas exists such as a hot-spring resort
 - d. Where there are considerable voltage fluctuations such as a factory or plant
 - e. Vehicles and vessels
 - f. A place like a kitchen with a lot of oil and vapor
 - g. Where there are machines generating electromagnetic waves
 - h. An areas filled with acid and/or alkaline steam or vapor
- **Is a snow protection measure taken?**
For details, consult your dealer.

Regarding wiring

- **All wiring must be performed by an authorized electrician.**
To do wiring, ask your dealer. Never do it by yourself.
- **Make sure that a separate power supply circuit is provided for this air conditioner or heat pump and that all electrical work is carried out by qualified personnel according to local laws and regulations.**

Pay attention to the installation location

- **Are the following places selected?**
 - a. A place that can sufficiently withstand the weight of the air conditioner or heat pump with minimal vibration and operation sound.
 - b. A place where the air discharged from the outlet of the outdoor unit and the running sound do not become bothersome.
- **Are you sure that there are no obstacles near the air outlet of the outdoor unit?**
Such obstacles may result in declined performance and increased running sound.
- **If abnormal sounds occur in use, stop the operation of the air conditioner or heat pump and consult your dealer.**

Regarding drainage of drain piping

- **Is the drain piping executed to perform complete drainage?**
If proper drainage is not carried out from the outdoor drain pipes during air-conditioning operation, chances are that dust and dirt are clogged in the pipe. This may result in a water leakage from the indoor unit. Under such circumstances, stop the operation of the air conditioner or heat pump, and then consult your dealer or our service station.

5. LABELS AND CORRESPONDING FUNCTIONS OF THE REMOTE CONTROLLER

Refer to figure 1 on page [1]

The illustrations in this operating manual correspond to the remote control format BRC1E type.

- 1. Operation mode selector button**
Used to change the mode.
- 2. Fan speed control button**
Used to change the fan control.

3. Menu/OK button

- Used to indicate the main menu.
(For details of the main menu, see the operation manual.)
- Used to enter the item selected.

Main Menu

Air Flow Direction
Ventilation
Schedule
Off Timer
Celsius / Fahrenheit
Maintenance Information
Configuration
Current Settings
Clock & Calendar
Daylight Saving Time
Language

*Depending on connected model

4. Up button ▲

- Used to raise the setpoint temperature.
- The previous menu items will be highlighted.
(The highlighted items will be scrolled continuously when the button is pressed continuously.)
- Used to change the selected item.

5. Down button ▼

- Used to lower the setpoint temperature.
- Items below the currently selected item will be highlighted.
(The highlighted items will be scrolled continuously when the button is pressed continuously.)
- Used to change the selected item.

6. Right button ►

- Used to highlight items to the right of the currently selected item.
- Display contents are changed to next screen per page.

7. Left button ◀

- Used to highlight items to the left of the currently selected item.
- Display contents are changed to previous screen per page.

8. On/Off button

Press once to operate, and press once again to stop.

9. Operation lamp

Green lamp lights up during operation. The lamp will blink if an malfunction occurs.

10. Cancel button

- Used to return to the previous screen.
- Press and hold this button for 4 seconds or longer to display service settings menu.

11. LCD (with backlight)

The backlight will illuminate for approximately 30 seconds by pressing any operation button.

⚠ NOTE

- Operate the button while the backlight is illuminated.
- When one indoor unit is controlled by two remote controllers (main / sub) only the first controller to be accessed by the user will illuminate its backlight.

6. OPERATION PROCEDURE

Read the operation manual that came with the remote controller.

- To protect the unit, turn on the main power switch 6 hours before operation.
- If the main power supply is turned off during operation, operation will restart automatically after the power turns back on again.

Part name and functions

In case of vertical position.

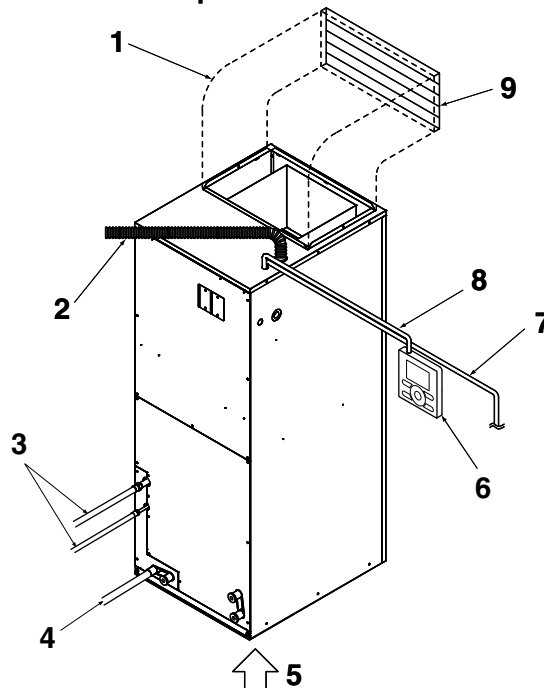

In case of horizontal position.

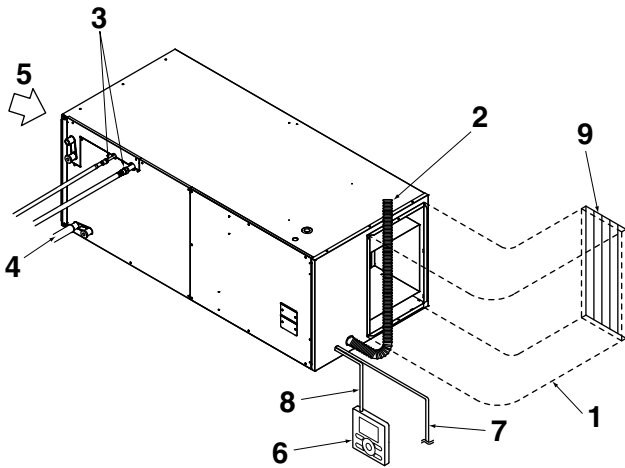

1. Airflow duct (local procurement)
2. Power supply wiring and ground wire through conduit
3. Refrigerant piping
4. Drain pipe
5. Air inlet
6. Remote controller
7. Transmission wiring
8. Controller wiring
9. Air outlet (local procurement)

BASIC OPERATION

COOL/HEAT/AUTO/FAN OPERATION

How to follow the operation manual

	Operation procedure	Operation button display
<p>Operation screen display Describes screens that will be displayed on the remote controller in operation.</p>	<p>Explains the sequence of operation for the remote controller. Operate the buttons according to the procedure.</p>	<p>Displays the location of buttons to be operated.</p>
<p>1</p>	<p>Display the main menu screen. Press ▼ buttons to select Schedule the main menu screen. Press Menu/OK button to display the timer screen.</p>	
<p>2</p>	<p>Before setting the schedule, the clock must be set. If the clock has not been set, a screen like the one on the left will appear. Press ▶ buttons to select Yes and press Menu/OK button. The date & time screen will appear. Set the current year, month, day, and time.</p>	

Preparation

- For mechanical protection purposes, apply power to the outdoor units at least six hours before starting the operation of the system.

OPERATION

1

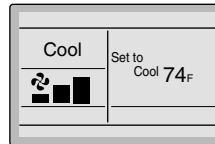

- Press the Operation mode selector button several times until the desired mode Cool, Heat, Fan, or Auto mode is selected.
- * Unavailable operation modes are not displayed.

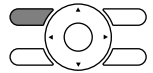

NOTE

- Before changing the mode, confirm that the display does not indicate master controlled status. Both heat and cool mode may not be selected if the unit is master controlled.

2



- Press On/Off button. The Operation lamp (green) will illuminate and the system will start operating.

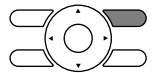

3

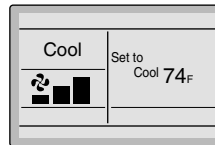

- The setpoint will increase by 1°F (or 1°C) when **▲** button is pressed and decrease by 1°F (or 1°C) when **▼** button is pressed.
- * Setpoint is not available in fan or dry mode.

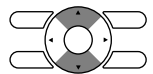

4

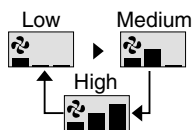
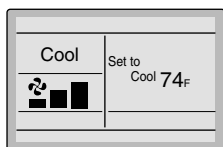

- To change the fan speed, press the Fan speed control button and select the desired fan speed from Low, Medium or High.

- * Only two fan speed adjustment levels, low and high may be available depending on the type of indoor unit.
- * The system may be in automatic fan speed control for equipment protection purposes.
- * The system may be in automatic fan speed control according to the room temperature. It is normal for the fan to intermittently stop operating.
- * It is normal for a delay to occur when changing the fan speed.

5

- Adjust Air Flow Direction from the main menu.

- * If the connected indoor unit model does not include oscillating louvers this function will not be available.

6



- When the On/Off button is pressed again, the system will stop operating and the operation lamp will turn off.

- * When the system is stopped while in the heating mode, the fan will continue to operate for approximately one minute to remove residual heat from the indoor unit.

NOTE

- To prevent water damage or system failure, do not immediately remove power from the indoor unit following system operation. Wait at least five minutes for the condensate pump to finishing draining residual water from the unit.

CHARACTERISTICS OF HEAT MODE

The system automatically controls the following operating modes to prevent the reduction of heating capacity and space comfort.

Defrost operation

- The system will automatically go into defrost operation to prevent frost accumulation at the outdoor unit and loss of heating capacity.
- The indoor unit fan will stop, and “STANDBY” (Defrost/Hot start) will be displayed on the remote controller.
- The system will return to normal operation usually within six to eight minutes (but not more than 10 minutes).

Hot start

- When the system goes into heat mode, the indoor unit fan will stop in order to prevent a cold draft. (In that case, “STANDBY” (Defrost/Hot start) will be displayed on the remote controller.)

DRY MODE

Preparation

- For equipment protection purposes, apply power to the outdoor units at least six hours before starting the operation of the system.
- The dry mode may not be selected if the remote controller is master controlled and the system is not already in the cooling mode of operation.

OPERATION

1

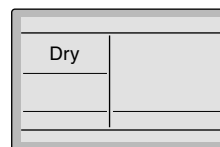

- Press Mode button several times until the Dry mode is selected.

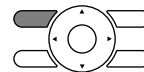

- * The dry mode may not be available depending on the type of indoor unit.

2



- Press On/Off button. The Operation lamp (green) will illuminate and the system will start operating.



* In Dry mode, the system maintains automatic temperature and fan speed control. Therefore, temperature setpoint or fan speed settings are not available while the indoor unit is in the Dry mode.

3

- Adjust Air Flow Direction from the main menu.

* If the connected indoor unit model does not include oscillating louvers this function will not be available.

4



- When the On/Off button is pressed again, the system will stop operating and the operation lamp will turn off.



NOTE

- To prevent water damage or system failure, do not immediately remove power from the indoor unit following system operation. Wait at least five minutes for the condensate pump to finishing draining residual water from the unit.

CHARACTERISTIC OF DRY MODE

- The Dry mode dehumidifies the space at reduced cooling capacity to prevent the room temperature from dropping to uncomfortable levels.

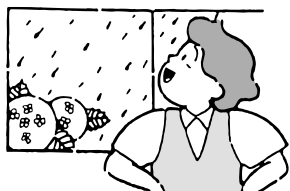

Refer to figure 3 on page [1]

1. Operation mode
2. Fan Speed
3. Setpoint display
4. Stand by for Defrost/Hot start
5. Message
6. (←●) display
7. (⊕) display
8. Under centralized control
9. Changeover controlled by the master indoor unit
10. Setback

Please refer to attached manual with remote controller for another operation.

7. OPTIMUM OPERATION

Observe the following precautions to ensure the system operates.

- Adjust the room temperature properly for a comfortable environment. Avoid excessive heating or cooling.
- Prevent direct sunlight from entering a room during cooling operation by using curtains or blinds.
- Ventilate the room regularly. Using the unit for long periods of time requires attentive ventilation of the room.
- Keep doors and windows closed. If the doors and windows remain open, air will escape and diminish cooling or heating operation.
- Never place objects near the air inlet and the air outlet of the unit. It may cause deterioration in the effect or stop in the operation.
- Turn off the main power supply switch when it is not used for long periods of time. When the main power switch is turned on, some watts of electricity is being used even if the system is not operating. Turn off the main power supply switch for saving energy. When reoperating, turn on the main power supply switch 6 hours before operation for smooth running (Refer to MAINTENANCE).
- When the display shows “Time to clean filter”, ask a qualified service person to clean the filters (Refer to MAINTENANCE).

8. MAINTENANCE (FOR SERVICE PERSONNEL)

⚠ WARNING

- Only a qualified person is allowed to perform maintenance.
- Before touching any connection wirings, be sure to shut off all power supply switches.
- Only qualified technicians should install optional parts.

Be sure to use optional parts specified by our company. Installation in your own manner may result in water leakage, electric shock or fire.

⚠ CAUTION

- Be sure to stop operation and shut the power switch off before cleaning the air conditioner or heat pump.
Otherwise, an electric shock or injury may result.
- Do not wash the air conditioner or heat pump with water.
Doing so may result in an electric shock.
- Consult with installation contractor for cleaning the inside of the air conditioner or heat pump.
In correct cleaning may break plastic parts or cause water leakage or electric shock.
- Use a Stable platform.
Be sure to stand on a Stable platform when cleaning the system.

⟨Maintenance and inspection⟩

- Clean the drain pan periodically. Drain pipes clogged with dust will cause water leakage.
- For cleaning, consult your Daikin dealer.
(Before each season when cooling or heating is required, clean the air conditioner or heat pump.)
- If the area around the indoor unit is very dusty, use a dust-proof cover (local procurement).

⟨Cleaning the inside of the indoor unit⟩

- It is necessary to clean the inside of the indoor unit periodically.
Since the cleaning requires special technology, request a Daikin dealer to clean them.

Daily maintenance:

⟨Cleaning the air filter⟩

- The air filter is field supply.

Explanation

- Removing the air filter except when cleaning the air conditioner or heat pump may result in accidents.

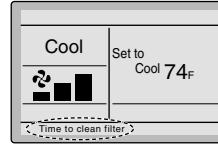

- When it is time to clean or replace the filter, one of the following messages will appear on the bottom of the basic screen.
“Time to clean filter”

- Wash, clean, or replace the filter or element.
- If using the air conditioner or heat pump under very dusty environment, increase the frequency of air filter cleaning.
- When you want to change the setting time until the “Time to clean filter” is displayed, consult with your dealer.
(The default factory setting is 2500 hours.)
- There are the following time, display pattern.
1250, 2500, 5000, 10000
- Air filter is field supply. In the time to clean filter and how to clean, please refer to the attached manual.

HOW TO CLEAN THE AIR FILTER

1. Remove the air filter.

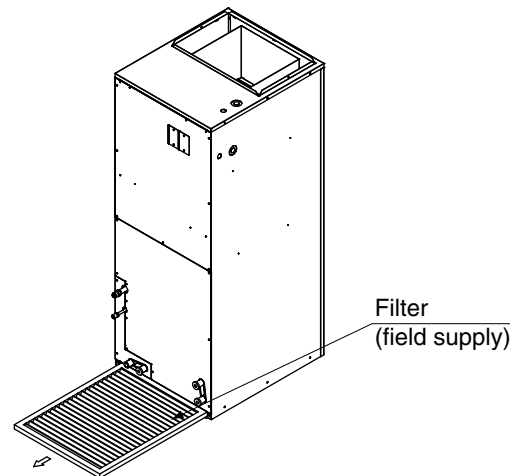

2. Clean the air filter.

Please refer to attached manual. (Air filter is field supply.)

Use a vacuum cleaner **A)** or wash the air filter with water **B)**.

A) Using a vacuum cleaner



B) Washing with water

When the air filter is very dirty, use soft brush and neutral detergent



Remove water and dry in the shade.

NOTE

- Do not wash it with hot water. Doing so may result in discoloration and/or deformation.
- Do not expose it to fire. Doing so may result in burning.

3. Attach the air filter.

Once cleaning is done, be sure to replace the air filter as it was.

- Reset the filter indicator when the filter is cleaned or replaced.
- Press Menu/OK button.
The main menu screen will appear.

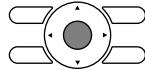

4. Push the “filter sign reset” button on the remote controller.

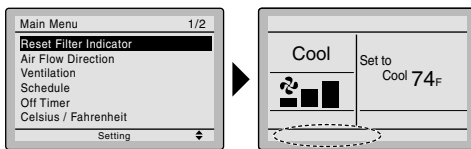

- Press ▼▲ buttons to select “Reset Filter Indicator” on the main menu screen and press Menu/Enter button.

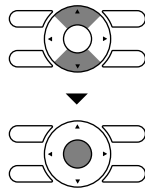

- The display shown in illustration will disappear from the basic screen when the filter sign is reset.

START UP AFTER A LONG STOP

Confirm the following

- Check that the air inlet and outlet are not blocked.
Remove any obstacle.
- Check if the ground is connected.
Might there be a broken wire somewhere?
Contact your dealer if there are any problems.

Clean the air filter

- After cleaning the air filter, make sure to attach it.

Turn on the main power supply switch

- The display on the remote controller will be shown when the power is turned on.
- To protect the unit, turn on the main power switch at least 6 hours before operation.

WHAT TO DO WHEN STOPPING THE SYSTEM FOR A LONG PERIOD

Turn on FAN OPERATION for a half day and dry the unit.

- Read the operation manual that came with the remote controller.

Shut off the power supply.

- When the main power switch is shut on, some watts of electricity is being used even if the system is not operating.
Turn off the main power supply switch for saving energy.
- The display on the remote controller will vanish when the main power switch is turned off.

Clean the air filter and the exterior.

- Be sure to replace the air filter to its original place after cleaning. Refer to “HOW TO CLEAN THE AIR FILTER”.

ELECTRIC HEATER REPLACEMENT INTERVAL

The electric heater should be replaced every 10 years.

- This replacement interval is a guideline for ensuring safe and trouble-free operation of the product for many years.

9. MALFUNCTIONS NOT RELATED TO HEAT PUMP

The following symptoms do not indicate heat pump malfunction

I. THE SYSTEM DOES NOT OPERATE

- **The system does not restart immediately after the ON/OFF button is pressed.**
If the OPERATION lamp lights, the system is in normal condition.
It does not restart immediately because a safety device operates to prevent overload of the system. After 3 minutes, the system will turn on again automatically.
- **The system does not restart immediately when TEMPERATURE SETTING button is returned to the former position after pushing the button.**
If the OPERATION lamp lights, the system is in normal condition.
It does not restart immediately because a safety device operates to prevent overload of the system. After 3 minutes, the system will turn on again automatically.
- **The system does not start when the display shows “” and it flashes for few seconds after pressing an operation button.**
This is because the system is under centralized control. Flashes on the display indicate that the system cannot be controlled by the remote controller.
- **The system does not start immediately after the power supply is turned on.**
Wait one minute until the micro computer is prepared for operation.

II. The fan speed is different from the setting.

- **Pressing the fan speed control button does not change the fan speed.**
- When the room temperature reaches the set temperature in heating mode, the outdoor unit stops and the indoor unit switches to whisper mode. This is to prevent the cool air from being blown directly onto anyone in the room.
- To protect electric parts, the unit operates with the airflow rate at H speed during ELECTRIC HEATER operation regardless of the remote controller indication.

III. WHITE MIST COMES OUT OF A UNIT

- **When humidity is high during cooling operation (In oily or dusty places)**
If the inside of an indoor unit is extremely contaminated, the temperature distribution inside a room becomes uneven. It is necessary to clean the inside of the indoor unit. Ask your Daikin dealer for details on cleaning the unit. This operation requires a qualified service person.
- **When the system is changed over to HEATING OPERATION after DEFROST OPERATION.**
Moisture generated by DEFROST becomes steam.

IV. NOISE OF HEAT PUMP

- **A ringing sound after the unit is started.**
This sound is generated by the temperature regulator working.
It will quiet down after about a minute.
- **A continuous “Whoosh” is heard when the system is in COOLING or DEFROST OPERATION.**
This is the sound of refrigerant gas flowing through both indoor and outdoor units.
- **A “Whoosh” sound is heard at the start or immediately after the stop of operation and at the start or immediately after the stop of DEFROST OPERATION.**
This is the noise of refrigerant caused by flow stop and flow change.
- **A continuous flow “Whoosh” sound is heard when the system is in COOLING OPERATION or at a stop.**
The noise is heard when the drain pump is in operation.

V. DUST FROM THE UNITS

- **Dust may blow out from the unit after starting operation after not being used for a while.**
Dust absorbed by the unit blows out.

VI. THE UNITS GIVE OFF ODORS

The unit absorbs the smell of rooms, furniture, cigarettes, etc., and then emits them.

VII. THE LIQUID CRYSTAL OF THE REMOTE CONTROLLER DISPLAY “Checking the connection. Please stand by”

- **This occurs immediately after the main power supply switch is turned on.**
This indicates that the remote controller is in normal condition and continues temporarily.

10. TROUBLE SHOOTING

- I. If one of the following malfunctions occurs, take the measures shown below and contact your Daikin dealer.

The system must be repaired by a qualified service person.

⚠ WARNING

If the air conditioner or heat pump is operating abnormally, such as a burning smell, unplug the power cord from the outlet, and contact your dealer

Continued operation under such circumstances may result in a failure, electric shock, and fire.

- If a safety device such as a fuse, a breaker or an ground leakage breaker frequently actuates;
Procedure: Do not turn on the main power switch, take the following actions.
- If the ON/OFF switch does not properly work;
Procedure: Turn off the main power switch
- If water leaks from unit.
Procedure: Stop the operation.

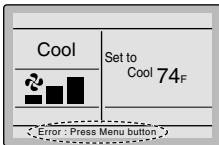

- If an error occurs, either one of the following items will flash in the basic screen.

“Error: Push Menu button”
* The operation lamp will flash.

“Warning: Push Menu button”
* The operation lamp will not flash.

- Press Menu/OK button.

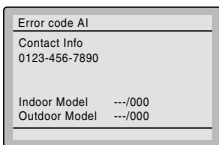
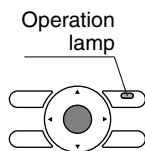

- The error code will flash and the service contact and model name or code may appear.
- Notify your Daikin dealer of the Error code and model name or code.

- II. If the system does not properly operate (except for the above mentioned case), and none of the other mentioned malfunctions are evident, investigate the system according to the following procedures:

1. If the system does not operate at all.

- Check if there is a power failure.
Wait until power is restored. If a power failure occurs during operation, the system automatically restarts immediately after the power supply recovers.
- Check if a fuse has blown.
Turn off the power supply.
- Check if the breaker is blown.
Turn the power on with the breaker switch in the off position.
Do not turn the power on with the breaker switch in the trip position.
(Contact your dealer.)

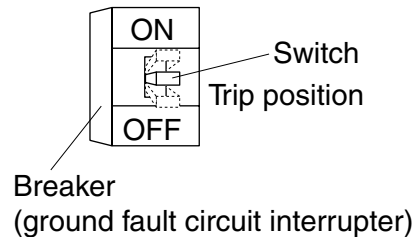

2. If the system stops operating it has been running normally.

- Check if the air inlet or outlet of outdoor or indoor unit is blocked by obstacles.
Remove the obstacle so that it is well-ventilated.
- Check if the air filter is clogged.
Ask a qualified service person to clean the air filters (Refer to HOW TO CLEAN THE AIR FILTER).

3. If the system operates but it does not sufficiently cool or heat, check if:

- If the air inlet or outlet of the indoor or the outdoor unit is blocked with obstacles.
Remove the obstacle to ensure it is well-ventilated.
- If the air filter is clogged.
Ask a qualified service person to clean the air filters (Refer to HOW TO CLEAN THE AIR FILTER).
- If the set temperature is not proper (Refer to ADJUSTMENT).
- If the FAN SPEED button is set to LOW SPEED (Refer to ADJUSTMENT).

- If the doors or the windows are open. Shut doors or windows to prevent wind from coming in.
- If direct sunlight enters the room (when cooling).
Use curtains or blinds.
- When there are too many inhabitants in the room (when cooling).
Cooling effect decreases if heat gain of the room is too large.
- The heat source of the room is excessive (when cooling).
Cooling effect decreases if heat gain of the room is too large.

DAIKIN AC (AMERICAS), INC.

1645 Wallace Drive, Suite 110
Carrollton, TX 75006

info@daikinac.com
www.daikinac.com

DAIKIN INDUSTRIES, LTD.

Head office:

Umeda Center Bldg., 2-4-12, Nakazaki-Nishi,
Kita-ku, Osaka, 530-8323 Japan

Tokyo office:

JR Shinagawa East Bldg., 2-18-1, Konan,
Minato-ku, Tokyo, 108-0075 Japan

